

ISSUE:	DRAWN BY:	CHECKED BY:	CRF NO:	DATE:	DESCRIPTION:
a	FT	KB	3507	29/5/25	First issue

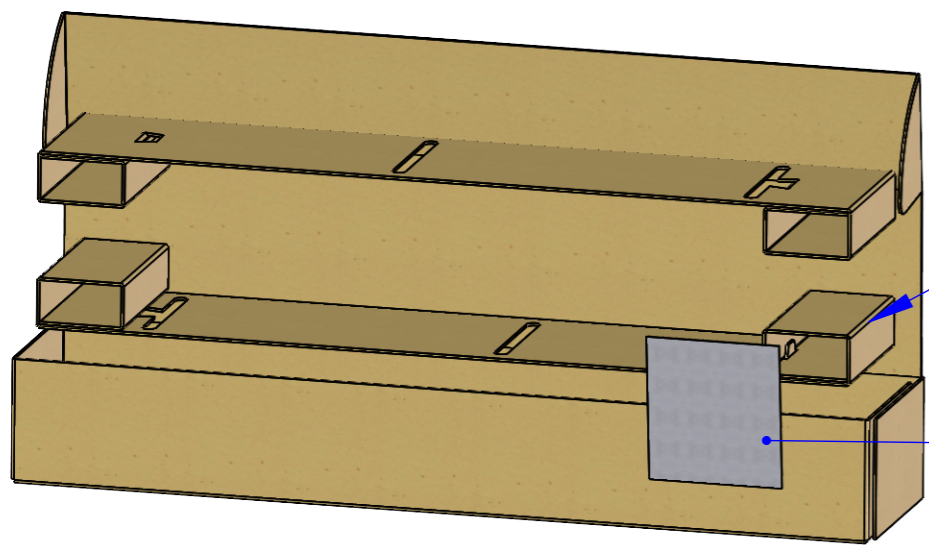

PA377 x 2  
AL Fitting Kit Box

LA038 x 1  
Printed Label, Kit Box

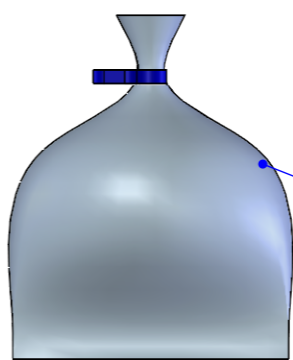

FK1049 x 1  
Aluminium Ladder Standard Bolt Kit 2 (M8x35)



LW019 x 1  
Ladder Front Mounting Bracket, Bent.

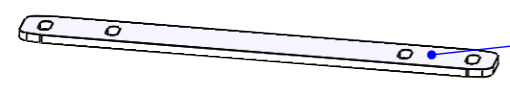

PS054 x 1  
Mounting Rubber, Universal Ladder Bracket



LR072 x 1  
VW Transporter T7 - Ladder Upper Bracket



PS632 x 1  
VW Transporter T7 - Ladder Upper Bracket Rubber Pad



LW020 x 1  
Ladder Front Bracket, Double Bend

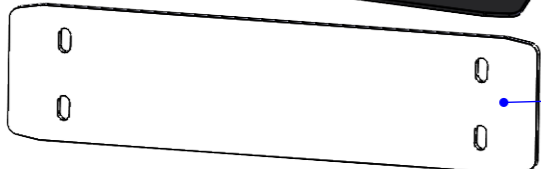

PS055 x 1  
Mounting Rubber, Vivaro Ladder Bracket

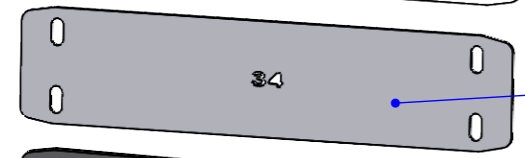

LR034 x 1  
Ladder Rear Spreader Plate, 4 Bolt

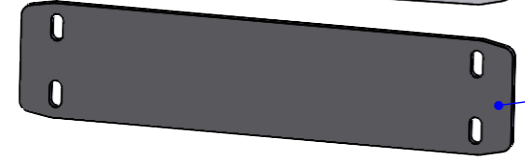

PS437 x 1  
Universal 4 Bolt Internal Bottom Pad

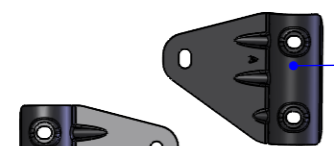

LR005 x 2  
Ladder Side Bracket, Form A

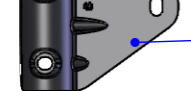

LR006 x 2  
Ladder Side Bracket, Form B

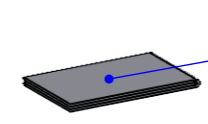

(INLK47) x 1  
Customer Instruction Sheet(s)

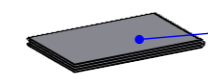

(RPI002) x 1  
Customer Instruction Sheet(s)

**Note:**  
See next page for example of how kit should be packaged.

MATING PARTS: n/a

DRAWING NO: <b>LK47 (1 of 7)</b>	DESCRIPTION: <b>Aluminium Ladder Fitting Kit, VW Transporter T7 2025- H1</b>	DESIGNED BY: F. Turnbull 29/5/25
MATERIAL SIZE: n/a	MATERIAL SPEC: n/a	WEIGHT: 3.41Kg
© NOTE: This drawing is the property of Rhino Products Ltd and must not be used or copied without written consent. The Rhino Products name and logo must remain clearly visible in any reproduction.		

IF IN DOUBT PLEASE ASK

 THIRD ANGLE PROJECTION	
UNLESS OTHERWISE SPECIFIED: DIMENSIONS ARE IN MM	
0.00	±0.2
0.0	±0.5
ANG	±0.5°
DERIVED DIMENSIONS SHOWN IN BRACKETS	
<F> - CRITICAL FIT DIMENSION	
<S> - SAFETY CRITICAL DIMENSION	
DEBURR AND BREAK ALL SHARP EDGES	
SHEET SIZE A3	SHEET SCALE: 1:5



ISSUE:	DRAWN BY:	CHECKED BY:	CRF NO:	DATE:	DESCRIPTION:
01	FT	KB	3507	29/5/25	First issue

# Packaged Example

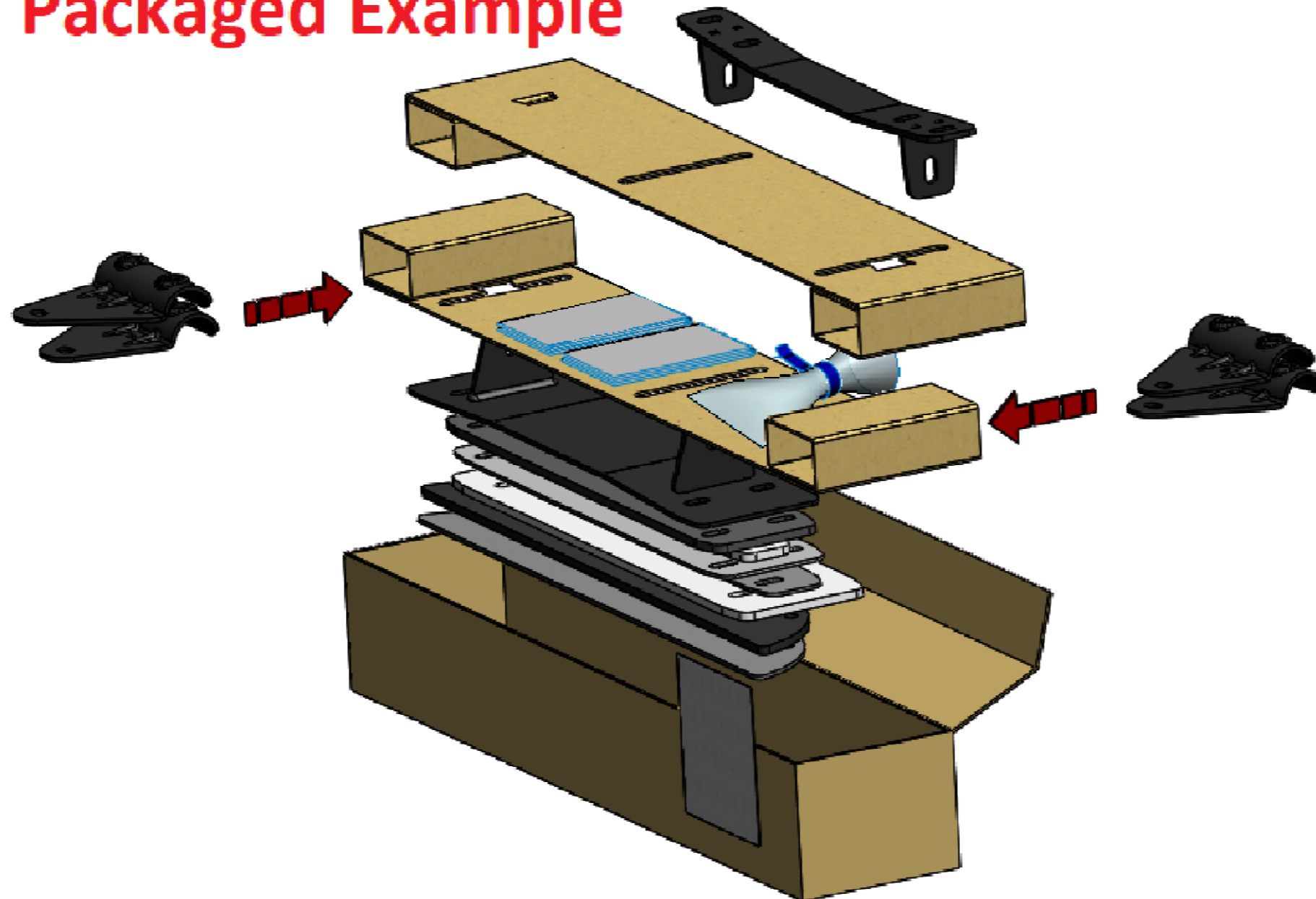

IF IN DOUBT PLEASE ASK

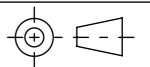

THIRD ANGLE PROJECTION

UNLESS OTHERWISE SPECIFIED:  
DIMENSIONS ARE IN MM

0.00 ±0.2  
0.0 ±0.5  
ANG ±0.5°

DERIVED DIMENSIONS SHOWN IN BRACKETS

<F> - CRITICAL FIT DIMENSION  
<S> - SAFETY CRITICAL DIMENSION

DEBURR AND BREAK ALL SHARP EDGES

SHEET SIZE A3 SHEET SCALE: 1:5

## MATING PARTS:

DRAWING NO: <b>LK47 (2of7)</b>	DESCRIPTION: <b>Aluminium Ladder Fitting Kit, VW Transporter T7 2025- H1</b>	DESIGNED BY: F. Turnbull 29/5/25
MATERIAL SIZE: n/a	MATERIAL SPEC: n/a	FINISH: n/a
		WEIGHT: 3.41Kg

© NOTE: This drawing is the property of Rhino Products Ltd and must not be used or copied without written consent. The Rhino Products name and logo must remain clearly visible in any reproduction.



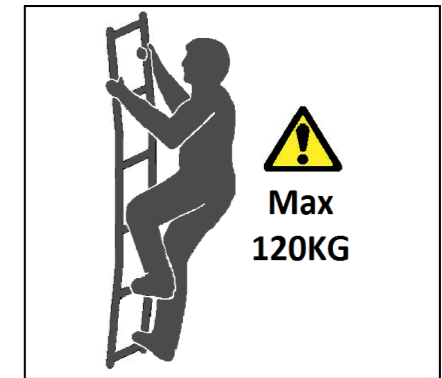
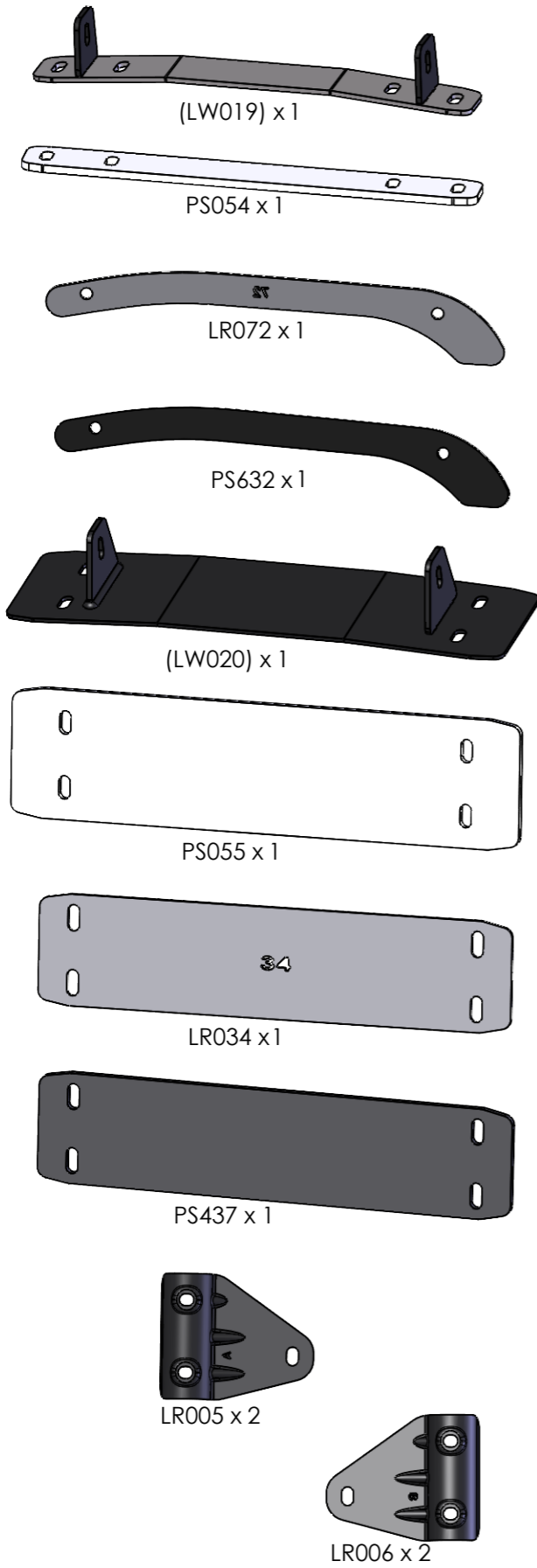

13mm x 2



4mm x 1



9mm x 1

